

SEACHANGE SERIES ®

CONTEMPORARY/ENGINEERED

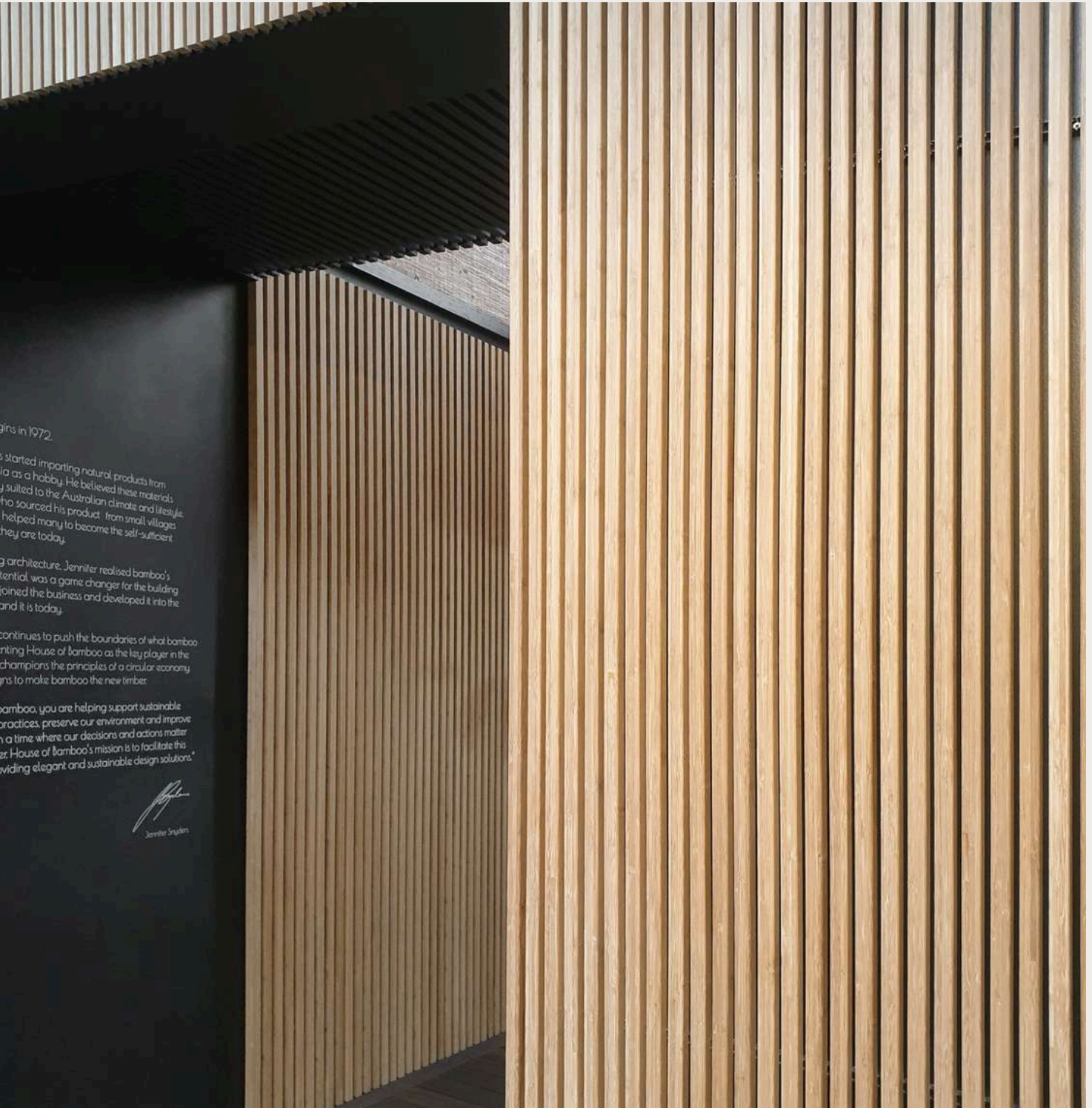

begins in 1972.

started importing natural products from
ia as a hobby. He believed these materials
y suited to the Australian climate and lifestyle.
ho sourced his product from small villages
helped many to become the self-sufficient
they are today.

g architecture. Jennifer realised bamboo's
potential was a game changer for the building
joined the business and developed it into the
and it is today.

continues to push the boundaries of what bamboo
making House of Bamboo as the key player in the
champions the principles of a circular economy
to make bamboo the new timber.

bamboo, you are helping support sustainable
practices, preserve our environment and improve
in a time where our decisions and actions matter
er. House of Bamboo's mission is to facilitate this
providing elegant and sustainable design solutions."

Jennifer Snyder

house of
bamboo
EST. 1972

www.houseofbamboo.com.au



SEACHANGE SERIES ®

Elegantly designed yet cleverly practical, our engineered laminated bamboo holds a Global GreenTag Level A rating, guaranteeing sustainable manufacturing practices. The SeaChange Series® helps deliver innovative and imaginative projects with elegant battens and pre-made screen solutions that are perfect for shading, privacy screening, fencing and cladding.

As a superior alternative to timber, these panels are engineered from laminated bamboo strips, creating slats that are lighter, stronger and more sustainable than traditional timber.

Fixed to anodised aluminium battens, creating modules that are ready for installation, the SeaChange Series® features a number of different styles delivering unlimited flexibility to transform your indoor and outdoor spaces.





COTTESLOE

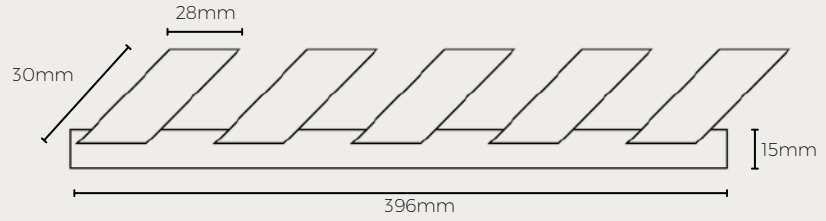

Note: Profile drawing are indicative and not to scale.

Colour	Length	Width	Thickness	Weight	Sku
Raw	1830mm	396mm	40mm	7.5kg	BATT-SEAC-COTTESLOE-W396-H1830-R
	2440mm	396mm	40mm	10kg	BATT-SEAC-COTTESLOE-W396-H2440-R

FREYCINET

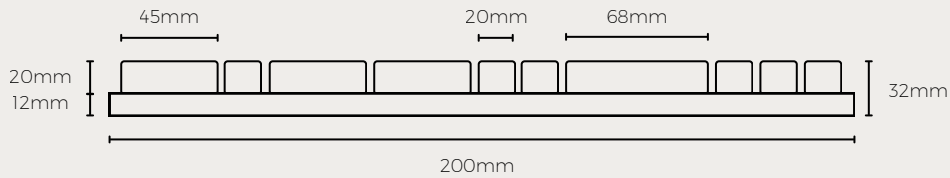

Note: Profile drawing are indicative and not to scale.

Colour	Length	Width	Thickness	Weight	Sku
Raw	2900mm	200mm	20mm	12.63kg	BATT-SEAC-FREYCINET-W200-H2900-R

HENLEY

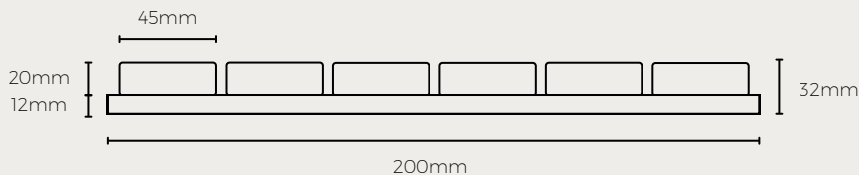

Note: Profile drawing are indicative and not to scale.

Colour	Length	Width	Thickness	Weight	Sku
Raw	2900mm	200mm	20mm	7.88kg	BATT-SEAC-HENLEY-W200-H2900-R

NOOSA

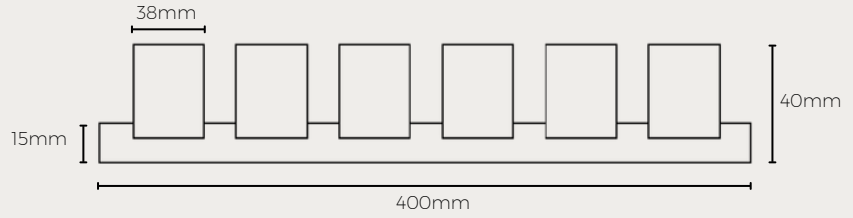

Note: Profile drawing are indicative and not to scale.

Colour	Length	Width	Thickness	Weight	SKU
Raw	2400mm	400mm	40mm	14.4kg	BATT-SEAC-NOOSA-W400-H2400-R
	2900mm	400mm	40mm	17.4kg	BATT-SEAC-NOOSA-W400-H2900-R

SAPPHIRE

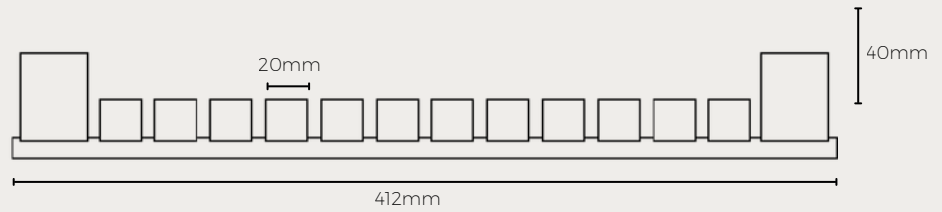

Note: Profile drawing are indicative and not to scale.

Colour	Length	Width	Thickness	Weight	SKU
Raw	1830mm	412mm	40mm	8.4kg	BATT-SEAC-SAPPHIRE-W412-H1830-R
	2440mm	412mm	40mm	11kg	BATT-SEAC-SAPPHIRE-W412-H2440-R

SILHOUETTE

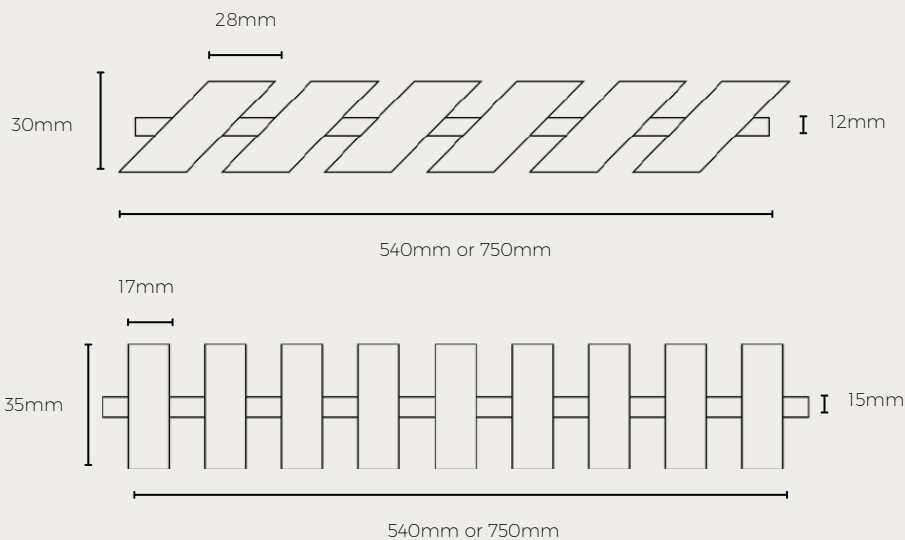

SILHOUETTE

Colour	Length	Width	Thickness	Sku
Louvred - Raw	2330mm	705mm	30mm	BATT-SEAC-SILHOUETTE-L-W705-H2330-R
	2650mm	540mm	30mm	BATT-SEAC-SILHOUETTE-L-W540-H2650-R
Slatted - Raw	2330mm	705mm	30mm	BATT-SEAC-SILHOUETTE-S-W705-H2330-R
	2650mm	540mm	30mm	BATT-SEAC-SILHOUETTE-S-W540-H2650-R

SORRENTO

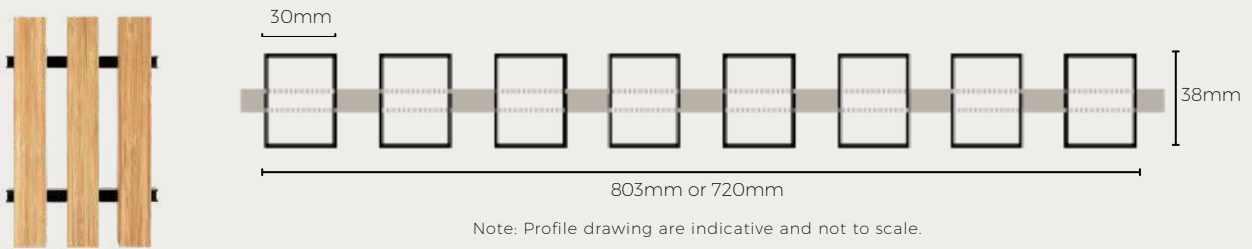

Colour	Length	Width	Thickness	Sku
Raw	1300mm	803mm	38mm	BATT-SEAC-SORRENTO-W803-H1300-R
	1380mm	720mm	38mm	BATT-SEAC-SORRENTO-W720-H1380-R

TORQUAY

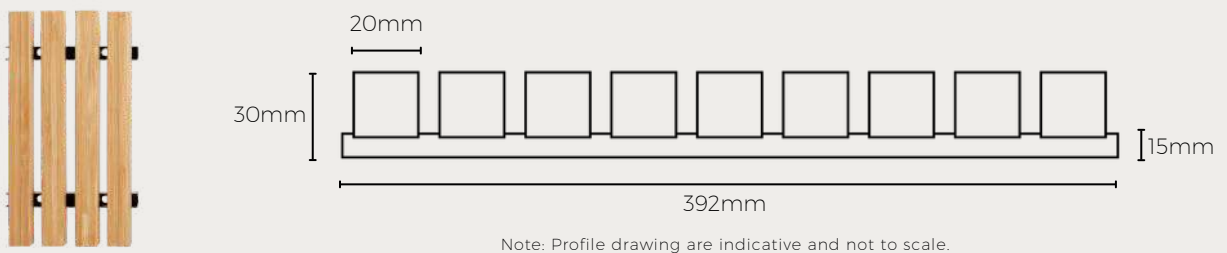

Colour	Length	Width	Thickness	Weight	Sku
Raw	1800mm	392mm	30mm	6.6kg	BATT-SEAC-TORQUAY-W392-H1800-R
	2100mm	392mm	30mm	7.9kg	BATT-SEAC-TORQUAY-W392-H2100-R
	2400mm	392mm	30mm	9.2kg	BATT-SEAC-TORQUAY-W392-H2400-R

*All our materials can be customised to suit your project. We can provide specialised sizes to meet your needs.

COTTESLOE - SB

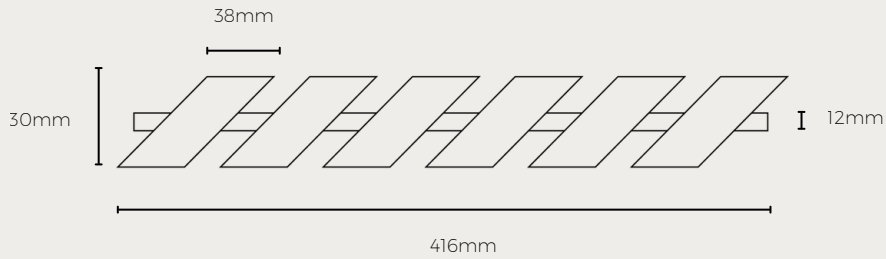

Note: Profile drawing are indicative and not to scale.

Colour	Length	Width	Thickness	Weight	Sku
Raw	2500mm	416mm	30mm	25.8kg	BATT-SEAC-COTTESLOE-SB-W416-H2500-R

NOOSA - SB

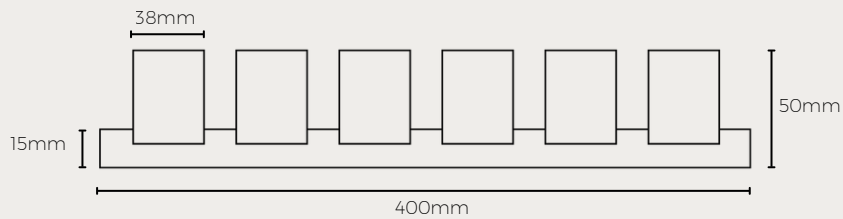

Note: Profile drawing are indicative and not to scale.

Colour	Length	Width	Thickness	Weight	Sku
Raw	2500mm	400mm	50mm	24.6kg	BATT-SEAC-NOOSA-SB-W400-H2500-R

TORQUAY - SB

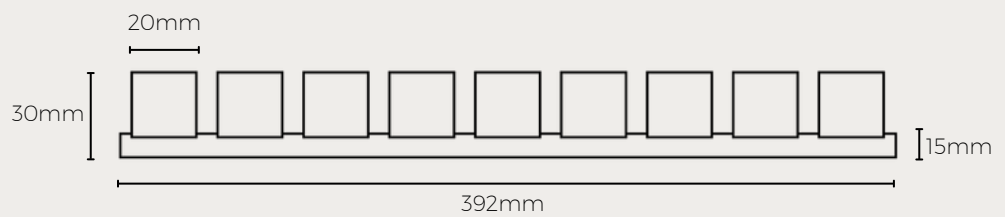

Note: Profile drawing are indicative and not to scale.

Colour	Length	Width	Thickness	Weight	Sku
Raw	1860mm	392mm	30mm	12.8kg	BATT-SEAC-TORQUAY-SB-W392-H1860-R
	2500mm	392mm	30mm	18.4kg	BATT-SEAC-TORQUAY-SB-W392-H2500-R

WOCA®

EXTERIOR OIL COLOUR

Seachange Series ®

Available in Natural, Teak, black. Or available by special order.

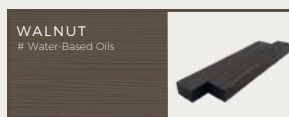
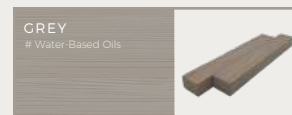
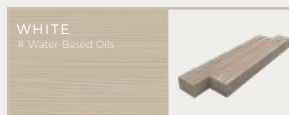
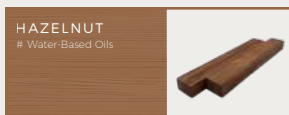
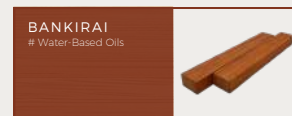
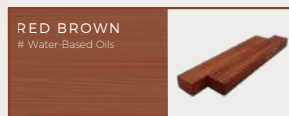
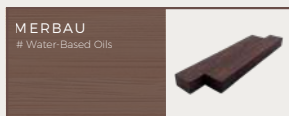
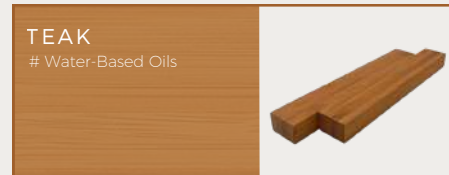
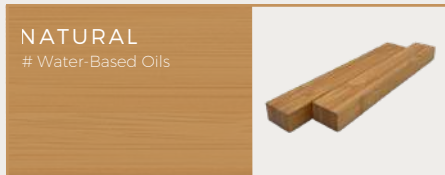

BAMBOO BENEFITS

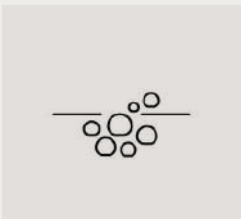

SOIL EROSION
PREVENTION &
RESTORATION

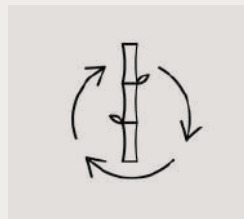

ZERO-WASTE
LIFE CYCLE

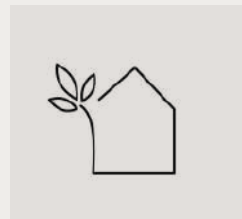

GREENHOUSE
GAS EMISSIONS



NATURAL
WATER
PURIFICATION

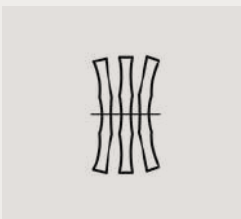

SHORT HARVEST
CYCLE



SELF-
REGENERATING
GROWTH

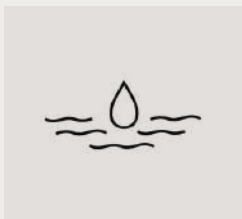

SUPERIOR WATER
RETENTION

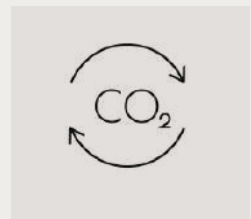

SUPERIOR
CARBON
SEQUESTRATION

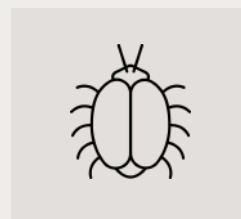

NATURALLY
RESISTANT
TO TERMITES

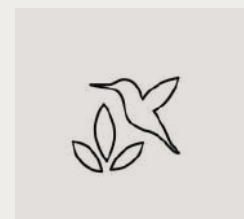

BIODIVERSITY
PRESERVATION



CLIMATE CHANGE
MITIGATION

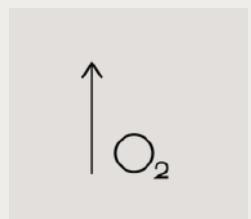

ENHANCED
OXYGEN
PRODUCTION



A BAMBOO LEGACY

At House of Bamboo®, we are carrying on a legacy that was founded last century, when Mark Snyders first began to source environmentally conscious bamboo. Recognised globally as a leading bamboo specialist, we are committed to creating beautiful, environmentally friendly bamboo products and encouraging Australians to embrace the benefits of bamboo.



A SUSTAINABLE FUTURE

In addition to being House of Bamboo® CEO, Jennifer Snyders also pursues her passion for sustainability by advocating bamboo projects throughout Australia and supporting land regeneration and reforestation.

Having qualified at UNSW with a Bachelor of Science (Architecture), she understands the incredible potential of bamboo and her sense of design and technical understanding has allowed her to develop a range of engineered bamboo products that can out perform timber.

HEAD OFFICE & SHOWROOM



13 Erith Street, Botany NSW 2019

DISPLAY CENTRE QLD

BUILD AND DESIGN CENTRE BRISBANE



66 Merivale Street, South Brisbane QLD 4101

CONTACT



For General Enquiries

info@houseofbamboo.com.au



Local or Interstate: 1800 240 996

International: (+61)2 9666 5703

ONLINE



www.houseofbamboo.com.au



[@house.of.bamboo.australia](https://www.instagram.com/house.of.bamboo.australia)

house of
bamboo

EST. 1972